

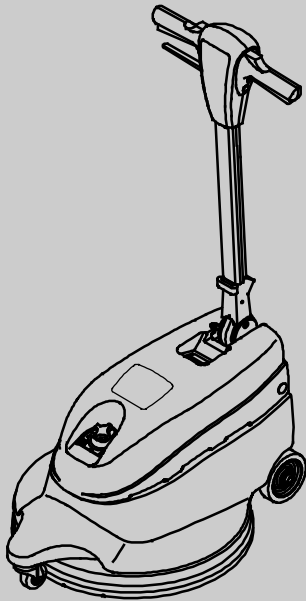

2370

Operator Manual **EN**



Model Part No.:
M23702004 (230V/50HZ)



For the latest Parts manuals and other
language Operator manuals, visit:

www.tennantco.com/manuals

1010337
Rev. 02 (07-2016)



This manual is furnished with each new model. It provides necessary operation and maintenance instructions.

Read this manual completely and understand the machine before operating or servicing it.

This machine will provide excellent service. However, the best results will be obtained at minimum costs if:

- The machine is operated with reasonable care.
- The machine is maintained regularly - per the machine maintenance instructions provided.
- The machine is maintained with manufacturer supplied or equivalent parts.

To view, print or download manuals online visit www.tennantco.com/manuals

Parts and supplies may be ordered online, by phone, by fax or by mail.



PROTECT THE ENVIRONMENT

Please dispose of packaging materials and old machine components in an environmentally safe way according to local waste disposal regulations.

Always remember to recycle.

MACHINE DATA

Please fill out at time of installation for future reference.

Model No. - _____

Serial No. - _____

Machine Options - _____

Sales Rep. - _____

Sales Rep. phone no. - _____

Customer Number - _____

Installation Date - _____

TABLE OF CONTENTS

SAFETY PRECAUTIONS 3
 GROUNDING INSTRUCTIONS 4

WARNING LABELS 4

MACHINE COMPONENTS 5

MACHINE SETUP 5
 INSTALLING PAD 5
 INSTALLING DUST CONTROL BAG 6

MACHINE OPERATION 6
 PRE- OPERATION CHECKS 6
 OPERATING MACHINE 6

MACHINE MAINTENANCE 7

ADJUSTING OR REPLACING BELT 8

STORING MACHINE 9

TRANSPORTING MACHINE 9

RECOMMENDED STOCK ITEMS 9

TROUBLE SHOOTING 10

SPECIFICATIONS 11

MACHINE DIMENSIONS 11

TENNANT N.V.
Industrielaan 6 5405 AB
P.O. Box 6 5400 AA Uden-The Netherlands

europe@tennantco.com
www.tennantco.com

Specifications and parts are subject to change without notice.

Original instructions, Copyright ©2010- 2016 Tennant Company, Printed in The Netherlands. All rights reserved.

SAFETY PRECAUTIONS

This machine is intended for commercial use only. It is designed exclusively to burnish hard floors in an indoor environment and is not constructed for any other use. Use only recommended burnishing pads and commercially available floor cleaners and waxes intended for machine application.

All operators must read, understand and practice the following safety precautions.

The following warning alert symbol and the "FOR SAFETY" heading are used throughout this manual as indicated in their description:

⚠ WARNING: To warn of hazards or unsafe practices which could result in severe personal injury or death.

FOR SAFETY: To identify actions which must be followed for safe operation of equipment.

Failure to follow these warnings may result in: personal injury, electrocution, electric shock, fire or explosion:

⚠ WARNING: Do Not Use Flammable Liquids Or Operate Machine In Or Near Flammable Liquids, Vapors Or Combustible Dusts.

This machine is not equipped with an explosion proof motor. The electric motor will spark upon start up and during operation which could cause a flash fire or explosion if machine is used in an area where flammable vapors/liquids or combustible dusts are present.

⚠ WARNING: Do Not Operate With Damaged Power Cord. Do Not Modify Plug. Unplug Power Cord Before Servicing Machine

If the supply cord is damaged or broken, it must be replaced by the manufacturer or it's service agent or a similarly qualified person in order to avoid a hazard.

⚠ WARNING: Do Not Use Outdoors. Do Not Expose to Rain. Store Indoors.

The following information signals potentially dangerous conditions to the operator or equipment:

FOR SAFETY:

1. Do not operate machine:

- With flammable liquids or near flammable vapors as an explosion or flash fire may occur.
- Unless trained and authorized.
- Unless operator manual is read and understood.
- Unless cord is properly grounded.

- With damaged cord or plug.
- If not in proper operating condition.
- In outdoor areas.
- In standing water.
- Without dust bag in place.
- With the use of an extension cord.

2. Before operating machine:

- Make sure all safety devices are in place and operate properly.
- Remove loose objects on floor to prevent dangerous projectiles if struck by spinning pad.

3. When using machine:

- Stay clear of spinning pad.
- Do not run machine over cord.
- Do not pull machine by plug or cord.
- Do not pull cord around sharp edges or corners.
- Wear non-slip shoes.
- Do not close doors on cord.
- Do not unplug by pulling on cord.
- Do not stretch cord.
- Do not handle plug with wet hands.
- Keep cord away from heated surfaces.
- Never activate the power when the handle is in the upright position.
- Do not release handles until pad comes to a complete stop.
- Go slow on inclines and slippery surfaces.
- Never allow children to play on or around.
- Report machine damage or faulty operation immediately.

4. Before leaving or servicing machine:

- Turn off machine.
- Unplug cord from wall outlet.

5. When servicing machine:

- Unplug cord from wall outlet.
- Avoid moving parts. Do not wear loose jackets, shirts, or sleeves.
- Use manufacturer supplied or approved replacement parts.
- All repairs must be performed by a qualified service person.
- Do not modify the machine from its original design.

6. When transporting machine:
- Get assistance when lifting machine.
 - Unplug cord from wall outlet.
 - Use tie-down straps to secure machine to truck or trailer.

The plug must be plugged into an appropriate outlet that is properly installed in accordance with all local codes and ordinances.

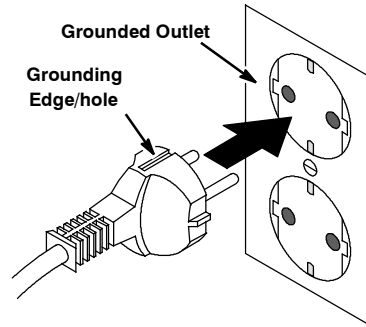

GROUNDING INSTRUCTIONS

Machine must be grounded. If it should malfunction or breakdown, grounding provides a path of least resistance for electrical current to reduce the risk of electrical shock. This machine is equipped with a cord having an equipment-grounding conductor and grounding plug.

WARNING LABELS

The warning labels appear on the machine in the locations indicated. Replace labels if they become damaged or illegible.

FLAMMABLE MATERIAL WARNING LABEL - Located on handle.



WARNING: Do Not Use Flammable Liquids Or Operate Machine In Or Near Flammable Liquids, Vapors Or Combustible Dusts.

This machine is not equipped with an explosion proof motor. The electric motor will spark upon start up and during operation which could cause a flash fire or explosion if machine is used in an area where flammable vapors/liquids or combustible dusts are present.

FOR SAFETY LABEL - Located on handle.



FOR SAFETY: Read manual before operating machine.

HAZARDOUS VOLTAGE LABEL - Located on handle.



WARNING: Do Not Operate With Damaged Power Cord. Do Not Modify Plug. Unplug Power Cord Before Servicing Machine.

If the supply cord is damaged or broken, it must be replaced by the manufacturer or it's service agent or a similarly qualified person in order to avoid a hazard.

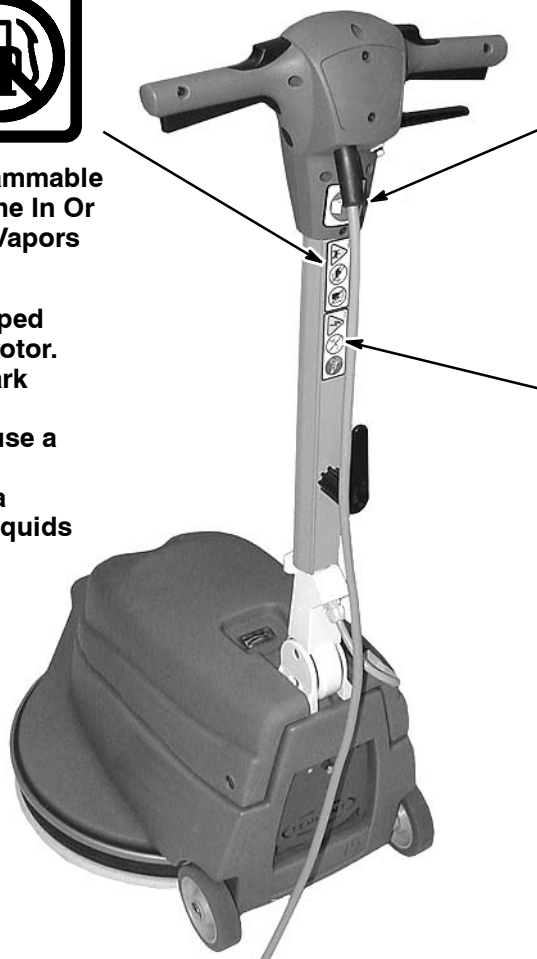

MACHINE COMPONENTS

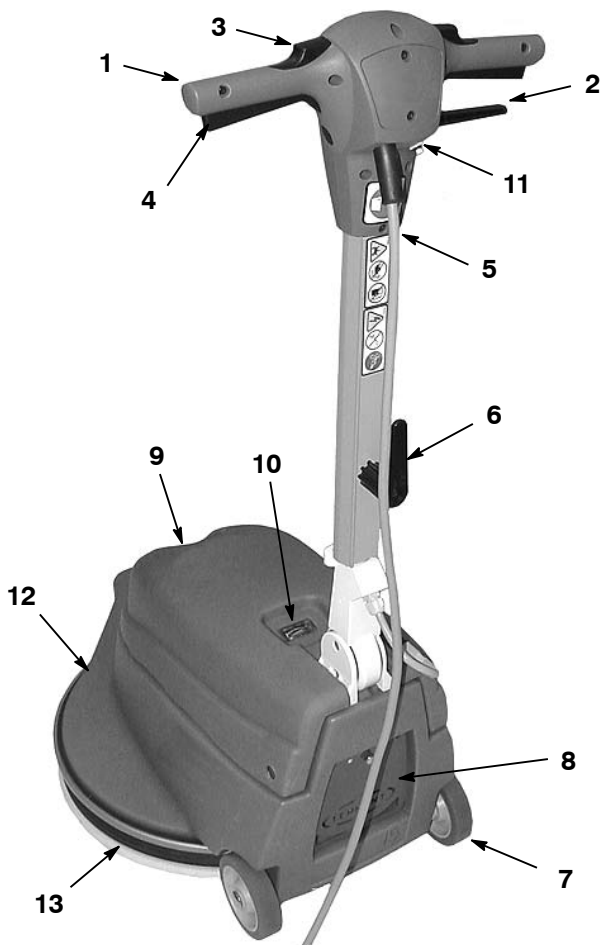

1. Adjustable Control Handle
2. Handle Height Adjustment lever
3. Safety Lock Buttons
4. On/Off Levers
5. 20 M Power Cord
6. Quick Release Power Cord Storing Hook
7. Transport Wheels
8. Dust Bag Compartment
9. Pad Pressure Adjustment Knob
10. Pad Pressure Meter
11. Circuit Breaker Reset Button
12. Base
13. Dust Control Skirt

MACHINE SETUP

Carefully check carton for signs of damage. Report damages at once to carrier.

INSTALLING PAD

1. Unplug the cord from the wall outlet.

FOR SAFETY: Before leaving or servicing machine, unplug cord from wall outlet.

2. Select and install a recommended high speed burnishing pad intended for 1700 rpm.

NOTE: Consult your authorized distributor for pad recommendations.

3. Adjust the handle to the upright position then carefully tilt the machine backwards and rest handle on floor (Figure 1).



FIG. 1

4. Remove the plastic centerlock ring from the pad driver. Position the pad on the pad driver and replace the ring securely by turning it clockwise (Figure 2).

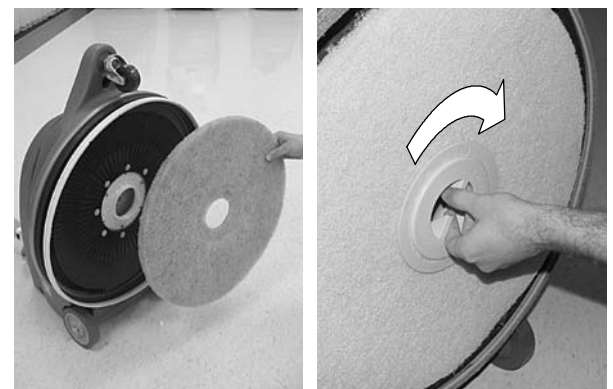

FIG. 2

5. After installing the pad, stand the machine upright.

INSTALLING DUST CONTROL BAG

1. Open the dust bag compartment at rear of machine by turning the knob counter-clockwise (Figure 3).
2. Slide the dust control bag collar over the intake tube as shown and close compartment (Figure 3).

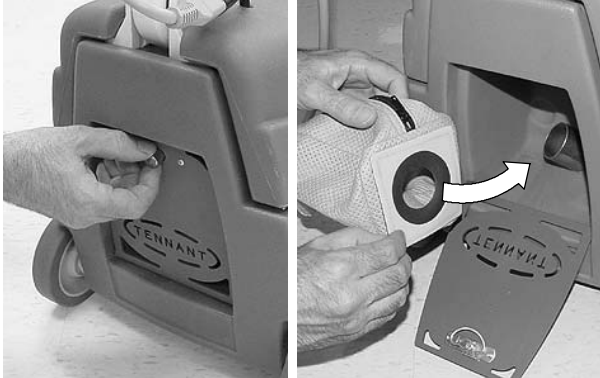

FIG. 3

MACHINE OPERATION

FOR SAFETY: Do not operate machine unless operator manual is read and understood.

PRE- OPERATION CHECKS

1. Sweep and dust mop the floor.
2. Inspect the condition of the burnishing pad.
3. Make sure the pad centerlock ring is secure.
4. Make sure the dust bag is installed and empty.
5. Inspect the power cord for damage. Replace cord immediately if damaged.
6. Check the dust skirt for wear and damage.
7. Make sure the dust skirt slightly touches the floor, readjust if necessary.

OPERATING MACHINE

⚠ WARNING: Do Not Use Flammable Liquids Or Operate Machine In Or Near Flammable Liquids, Vapors Or Combustible Dusts.

This machine is not equipped with an explosion proof motor. The electric motor will spark upon start up and during operation which could cause a flash fire or explosion if machine is used in an area where flammable vapors/liquids or combustible dusts are present.

1. Pull and turn the quick-release cord hook upward and remove the power cord from the machine (Figure 4).

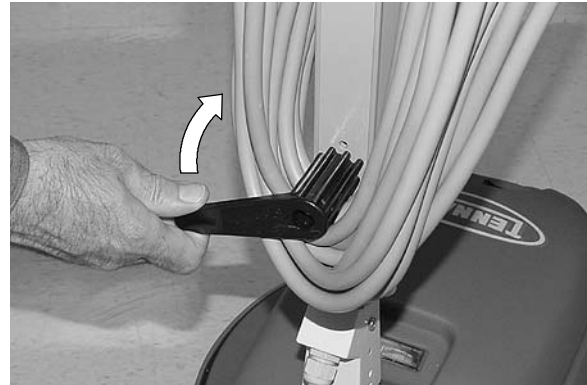

FIG. 4

2. Plug the power cord into a grounded wall outlet (Figure 5).

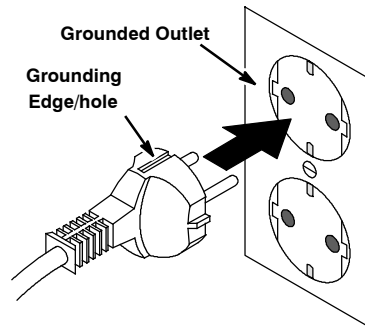

FIG. 5

FOR SAFETY: Do not operate machine unless cord is properly grounded. Do not operate machine with damaged cord or plug. Do not operate machine with the use of an extension cord.

3. Lower the handle to a desired operating height by pulling the handle height adjustment lever. Release lever to engage handle (Figure 6).



FIG. 6

- To start machine, depress the safety lock buttons, located on top of the handle, then pull the On/Off levers. Release the safety lock buttons once the machine starts (Figure 7).

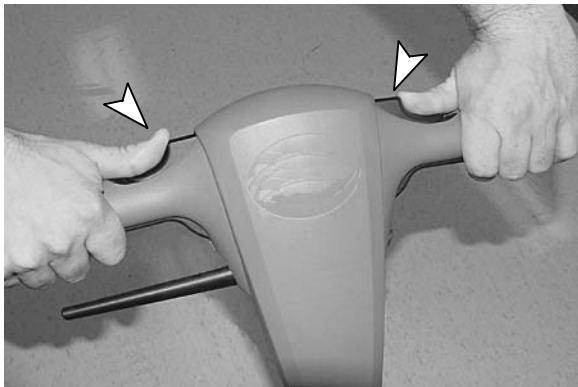

FIG. 7

NOTE: As a safety feature, the handle must be lowered from the upright position in order to activate the ON/OFF levers.

- To adjust the pad pressure, turn the adjustment knob counter-clockwise to increase pad pressure and clockwise to decrease (Figure 8).

ATTENTION: Do not adjust the pad pressure meter into the red zone, motor and floor damage may result.



FIG. 8

The machine's circuit breaker will trip under conditions of excessive motor overload. If circuit breaker should trip, readjust the pad pressure, change to a less aggressive pad and periodically check pad for soil build-up. To reset circuit breaker, unplug power cord, wait at least 15 seconds then press the reset button located on handle.

- Begin burnishing by working away from the cord and wall outlet. Use a forward and backward "W" motion or a straight path and return pattern.

FOR SAFETY: When using machine, stay clear of spinning pad.

- Do not operate the machine in the same spot for a long period of time. Floor damage may result.
- To maneuver over thresholds and floor grates, stop the machine and tilt it back on the rear wheels.

FOR SAFETY: When transporting machine, get assistance when lifting machine.

- To stop burnishing, release the On/Off levers. The safety lock buttons will automatically engage.

FOR SAFETY: When using machine, do not release handles until pad comes to a complete stop.

- When finished burnishing perform the following machine maintenance procedures.

MACHINE MAINTENANCE

FOR SAFETY: Before servicing machine, unplug cord from wall outlet.

- After each use, inspect the burnishing pad for wear. If worn, remove the pad and flip it over or replace it (Figure 9).

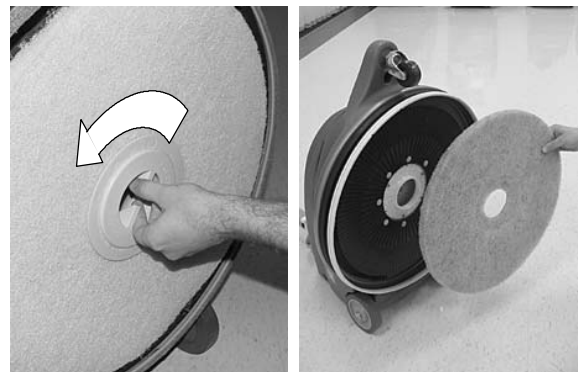

FIG. 9

- Remove and empty the dust bag after each use (Figure 10). Shake bag vigorously to remove all dust.



FIG. 10

3. Clean the machine with an all purpose cleaner and damp cloth after each use (Figure 11).



FIG. 11

4. Check the condition of the dust skirt. Replace skirt if worn or damaged (Figure 12). Make sure that the skirt just touches the floor all the way around.



FIG. 12

5. Inspect the power cord for damage after each use. If damaged, replace cord immediately.
6. Wipe the power cord with a damp cloth and neatly coil it around cord hook and handle after each use.
7. Periodically check that all bolts and nuts are tight.

⚠ WARNING: Do Not Operate With Damaged Power Cord. Do Not Modify Plug. Unplug Power Cord Before Servicing Machine

ADJUSTING OR REPLACING BELT

FOR SAFETY: Before servicing machine, unplug cord from wall outlet.

To adjust or replace the belt, follow the instructions as described below:

1. Remove the pad driver and the motor cover from the machine (Figure 13).

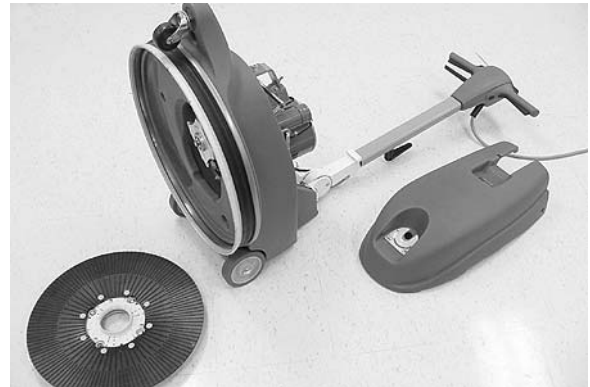

FIG. 13

2. Loosen the four motor mount screws and the tension bolt jam nut as shown (Figure 14).

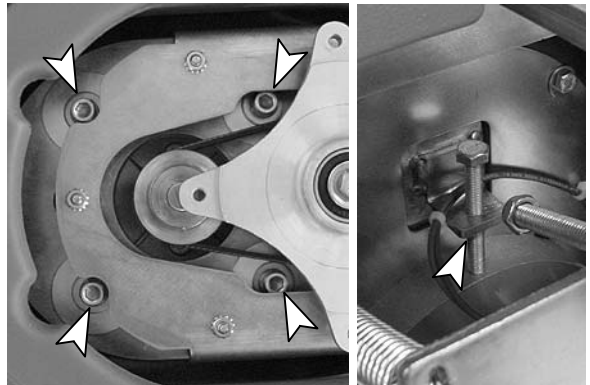

FIG. 14

3. Place the belt around the pulleys.
4. Turn the tension bolt clockwise until the mid point of the belt measures 6mm deflection at 4.5 Kg of force (Figure 15).

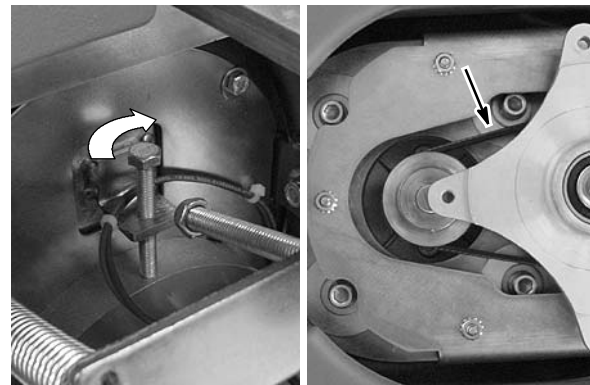

FIG. 15

5. Retighten the motor mount screws and the jam nut when properly adjusted.
6. Replace motor cover and pad driver.

STORING MACHINE

1. Unplug the power cord and remove the pad from the machine. Neatly coil the cord around the cord hook and handle to prevent cord damage (Figure 16).
2. Store the machine in a dry area with the handle positioned upward or folded down.
3. For minimal storage space, fold the handle down and store the machine as shown (Figure 16).



FIG. 16

⚠ WARNING: Do Not Use Outdoors. Do Not Expose to Rain. Store Indoors.

TRANSPORTING MACHINE

1. Unplug the power cord and remove the pad from the machine. Neatly coil the cord around the cord hook and handle.
2. Load the machine using a recommended loading ramp or carefully lift the machine with adequate assistance.

FOR SAFETY: When transporting machine, get assistance when lifting machine.

3. Secure machine with tie-down straps when transporting by vehicle.

⚠ WARNING: Do Not Use Outdoors. Do Not Expose to Rain. Store Indoors.

RECOMMENDED STOCK ITEMS

Refer to the Parts List Manual for recommended stock items.

To view, print or download Parts manual online visit www.tennantco.com/manuals

TROUBLE SHOOTING

PROBLEM	CAUSE	SOLUTION
Machine does not operate.	Machine is unplugged.	Plug machine in.
	The cord connection between the handle and the base is not properly connected.	Ensure proper cord connection.
	Machine circuit breaker tripped.	Reset the circuit breaker on machine.
	Building circuit breaker tripped.	Reset circuit breaker in building.
	Faulty power cord.	Contact Service Center.
	Faulty wiring.	Contact Service Center.
	Faulty On/Off Lever Switch.	Contact Service Center.
Machine circuit breaker trips continuously.	Excessive pad pressure.	Adjust pad pressure knob.
	Heavily soiled pad.	Replace Pad.
	Improper pad for application	Change to proper pad.
	Faulty circuit breaker.	Contact Service Center.
Pad does not spin or spins slowly.	Loose belt.	Tighten belt tension (See ADJUSTING OR REPLACING BELT).
	Broken belt.	Replace belt (See ADJUSTING OR REPLACING BELT).

SPECIFICATIONS

MODEL	2370
LENGTH	826mm
WIDTH	572mm
HEIGHT	1232mm
HEIGHT - HANDLE FOLDED	483mm
WEIGHT	47 Kg / 44 Kg less power cord
DRIVE MOTOR	230V 50Hz, 1.1 kW, 1564W, 6.8A, 2850rpm
PAD/BRUSH SPEED	1700 rpm
BRUSH PAD DIAMETER	508mm
DECIBEL RATING AT OPERATOR'S EAR, INDOORS ON TILE FLOOR	66dB(A)
POWER CORD LENGTH	20m
OPERATING VOLTAGE	230V 50Hz

Specifications are subject to change without notice.

MACHINE DIMENSIONS

